

PuG 10RF/2319i/120x100x203x148x1223x/358p/DN80 PN16/316/316L by **Pulse Guard**

1356

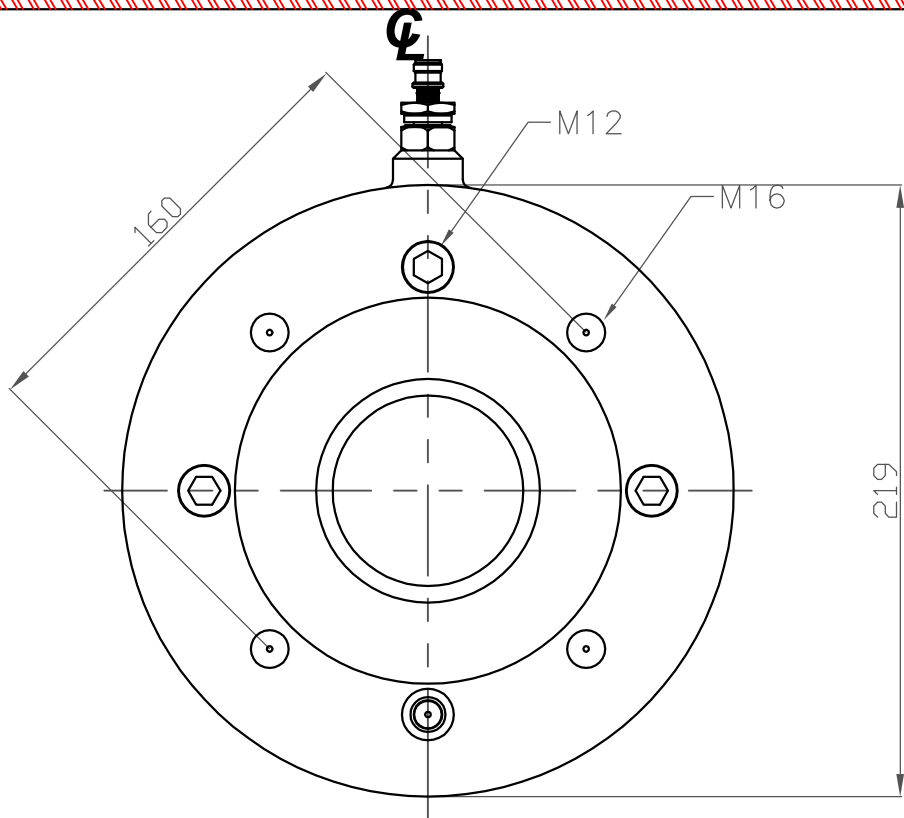
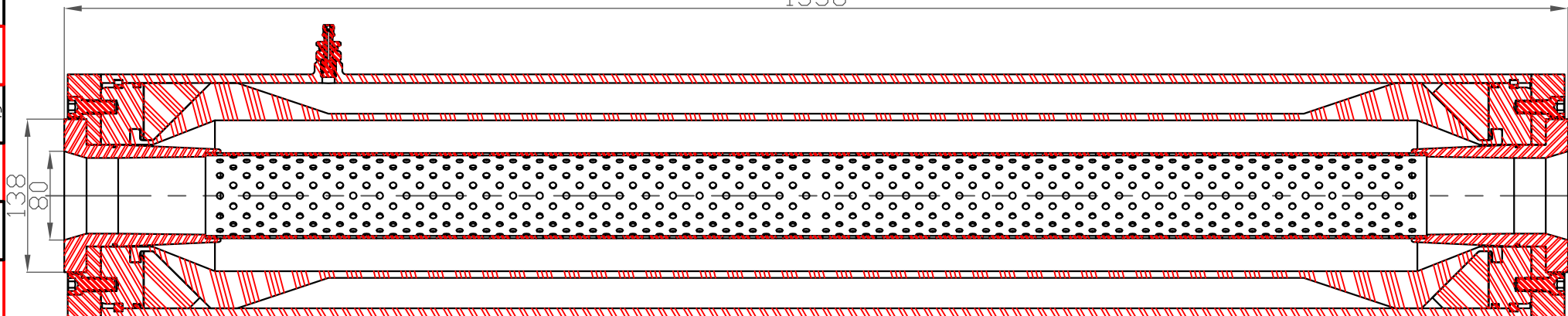

PulseGuard <http://www.PulseGuard.com>
<http://www.PulseGuard.co.uk>
PulseGuard für Deutschland www.pulsationdaempfer.com
PulseGuard, de langue Francaise amortisseurs-des-pulsations.com
PulseGuard, en Espanol / sud Amerique amortiguador-de-pulsaciones.com
PulseGuard, для Русскоговорящих pulsations-dampfer.com
PulseGuard is the USA registered trade mark of Pulseguard Inc.
PulseGuard is the UK registered trade mark of Pulseguard Ltd.